

# INSTALLATION MANUAL

**HUBER+SUHNER AG**  
Fiber Optics  
Fiber Management Systems  
DOC-0000642923 Rev A  
Date: 28/04/2015

Page 1 of 4

## SmartCabin

### Table of contents

- INSTALLATION OF THE CABINET ..... 1
- MICRODUCT AND CABLE FIXATION ..... 2
- CASSETTES AND SPLICING ..... 4



## INSTALLATION OF THE CABINET

### Step 1

Please use the included mounting instruction

Scope of delivery:  
- According BOM

Required tools:  
- Fiberoptic equipment and tools

Montageanweisung  
Mounting Instructions



### Gehäuse / Cabinet

82  
UNI 4  
UNI 6  
UNI 8  
UNI 11  
UNI 15

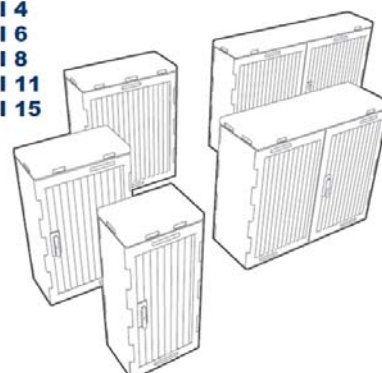



Basismontageanweisung (Standardgehäuse)  
Basic mounting instructions (Cabinet standard)

### Step 2

In case of any question regarding fixation of the cabinet, please check the homepage.

[www.sichert.com](http://www.sichert.com)

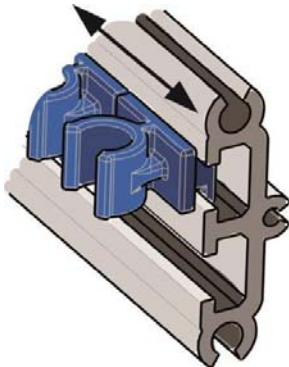
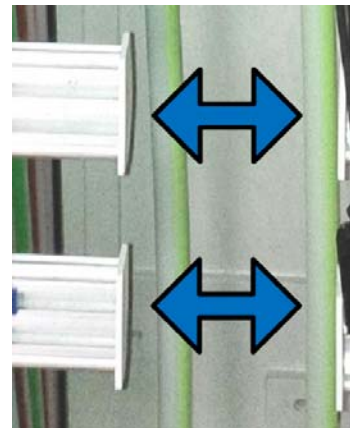
HUBER+SUHNER disclaims any liability resulting from incorrect installation and use, including any damages resulting from the use of tools and accessories other than the ones recommended herein. Any installation performed by unqualified personnel voids the product warranty provided by HUBER+SUHNER. All due care and attention must be exercised when performing the installation of these products. For advice concerning the general handling of these products please contact HUBER+SUHNER.

MICRODUCT AND CABLE FIXATION		
<b>Step 3</b>	Slide the micro-duct fixation clips into the rails	
<b>Step 4</b>	Fix the end caps at the end of the rail	
<b>Step 5</b>	Feed the micro ducts through the foam-pad (work from back to front) and fix the micro duct bundles in the base of the cabinet.	

HUBER+SUHNER disclaims any liability resulting from incorrect installation and use, including any damages resulting from the use of tools and accessories other than the ones recommended herein. Any installation performed by unqualified personnel voids the product warranty provided by HUBER+SUHNER. All due care and attention must be exercised when performing the installation of these products. For advice concerning the general handling of these products please contact HUBER+SUHNER.

**Step 6**

Snap the micro ducts into the clips (Cut the ducts close above the clip and fit the gas blocker or the blind cap)



**Step 7**

Fix incoming tubes or loose tube cables to the cable fixing plate

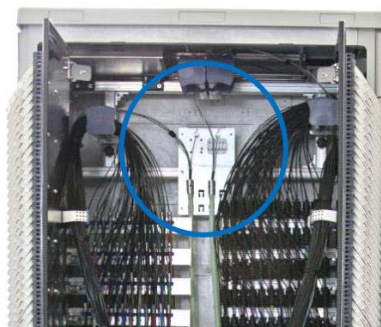

**Step 8**

After blowing in the cables, guide them over the mandrels to the front side with the cassettes.



HUBER+SUHNER disclaims any liability resulting from incorrect installation and use, including any damages resulting from the use of tools and accessories other than the ones recommended herein. Any installation performed by unqualified personnel voids the product warranty provided by HUBER+SUHNER. All due care and attention must be exercised when performing the installation of these products. For advice concerning the general handling of these products please contact HUBER+SUHNER.

**CASSETTES AND SPLICING**

**Step 9** Fix the cable at the bottom of the ACS routing plate or sideways with CRC set at the ACS base

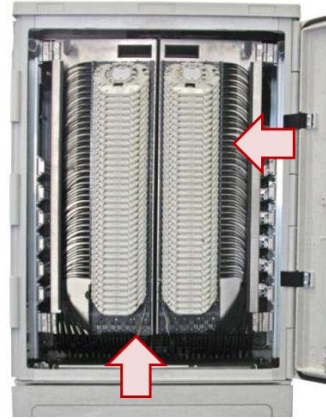

**Step 10** CRC sleeves according to DOC-0000603686



**Step 11** ACS Cassettesystem according to DOC-0000403728

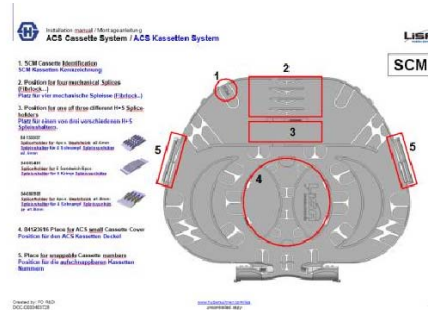

HUBER+SUHNER disclaims any liability resulting from incorrect installation and use, including any damages resulting from the use of tools and accessories other than the ones recommended herein. Any installation performed by unqualified personnel voids the product warranty provided by HUBER+SUHNER. All due care and attention must be exercised when performing the installation of these products. For advice concerning the general handling of these products please contact HUBER+SUHNER.