

INSTALLATION MANUAL

MASTERLINE Flex Box

Table of contents

• GENERAL INFORMATION	1
• NOTES IN THIS MANUAL	1
• NOTES ON THE FULFILMENT OF LEGAL CRITERIA	1
• INSTALLATION	2

GENERAL INFORMATION

Read the cable system user manual and installation manual carefully. General safety instructions apply unless this document stipulates more specific instructions. HUBER+SUHNER declines all liability and claims if the specifications are not met.

NOTES IN THIS MANUAL

The following symbols are used in this manual.



Info notes:

Info notes contain important instructions for installation and proper use of the product throughout its life cycle. The info notes also indicate that non-compliance may result in material damage or financial loss.



Notes about hazards and safety precautions:

Notes which indicate that non-compliance may result in danger to life and limb, as well as to material damage. It is imperative that these notes are heeded.

NOTES ON THE FULFILMENT OF LEGAL CRITERIA

The installation of optical communications systems requires that requisite permits be obtained from all the competent authorities. The installation technician is responsible for compliance with all applicable regulatory restrictions, usage regulations and other guidelines. This applies to permanent and temporary installations.

- Ascertain the applicable restrictions and usage regulations prior to installation.
- Draw up a cable-laying plan prior to installation.
- Check the finished system for compliance with usage and safety regulations.

INSTALLATION

Step 1:

Opening and closing of the MLFB:



Handling with the box:

The MLFB box has edges and an opening mechanism which requires the use of screw-drivers. Use protective gloves and work carefully to avoid trapping or hurting fingers or other parts of the body.



Open and close MLFB box :

To open and close of the lid, open and close the 4 screws of the box with an appropriate screw driver.



Step 2:

Change of hinge side:



Open lid :

Open the lid so that the hinges can be pushed over the cam.



Slide the lid out :

When the correct position is reached, slide the lid down and open the hinge.



Change of positions of hinge :

Change the two hinge pins to the other side.



Re-mounting of lid :

Fasten the lid to the other side in reverse order.



Step 3:

Remove box from bracket:



Handling with the box:

The MLFB box has edges and an opening mechanism which requires the use of screwdrivers. Use protective gloves and work carefully to avoid trapping or hurting fingers or other parts of the body.



Remove box from bracket:

Open the MLFB and insert 2 screwdrivers in the two slots provided. Push the two screwdrivers down so that the two tabs are pushed outwards. Now the upper case can be separated from the bracket.

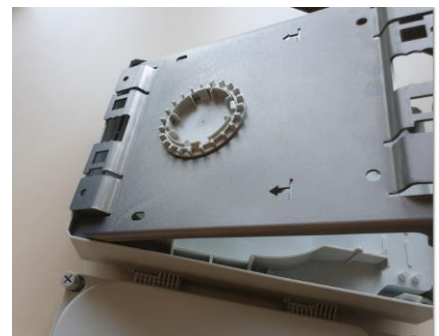
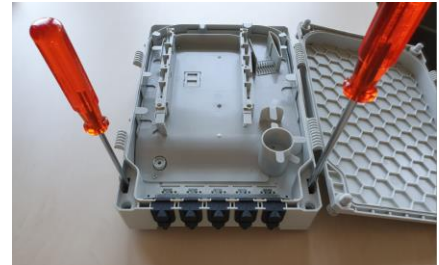

Step 4:

Fixing on wall and pole:



Mast and wall mounting:

The MLFB system can be mounted either on the mounting holes marked with a red circle (hole diameter: 6.5 mm) or over the bracket using hose clamps. Please heed the instructions given by the manufacturer of the fixing materials.



Wall mounting:

Make sure that the wall on which the MLFB is mounted provides sufficient support for dowels and screws. Use suitable screws and make sure that the screws are used according to the manufacturer's specification..



Mast mounting:

Always use hose clamps to fix the MLFB to a mast. Guide the hose clamps at the bottom into the lug provided and then secure them to the mast.

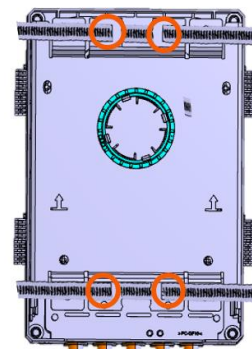
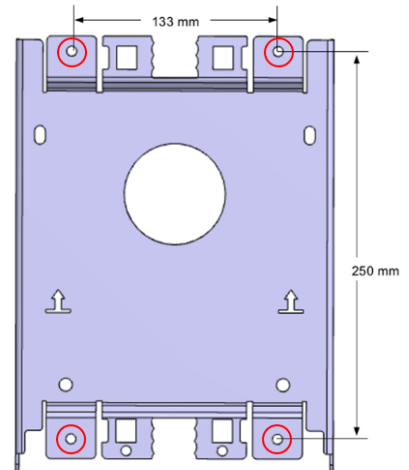

Step 5:

Cable insertion:



Insertion of cable, fixation with cable ties :
Suitable tools are required to remove the protective cover and attach the fibre optic cable. Use these tools only according to the manufacturer's instructions.



The protective covers of split grommets must be removed with a suitable tool. .



Use a cable tie to fix the fibre optic cable to the intended location. .



Use a cable tie to fix the fibre optic cable to the intended location. .



Tightening force of cable ties :
The cable ties may only be tightened slightly so that there are no visible impressions on the cable sheath.

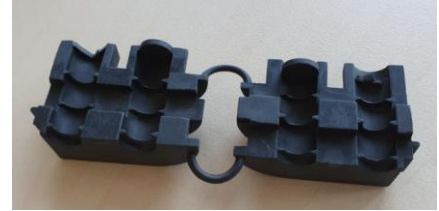



Step 6:

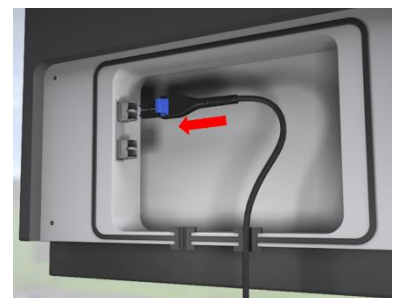

Use jumper cable to connect the MLFB. The connectors can be engaged in the ports provided by applying gentle pressure. Turn it gently in the opposite direction to check that the connector is properly engaged. Please refer to the general instructions in the user manual for guidance on handling cables and laying multi-connector cables.



Step 7:	 <p>All jumper cables must be secured according to national and local regulations. The weight of the cable must be supported by suitable cable fasteners.</p>	
Step 8:	 <p>Once all the jumper cables have been connected, the main line cable can be connected.</p>	